

# Planer / 3D Neon Series

## Dot-Free 12W 24V

The Bright Opal LED FlexLinear SV LED strip features High efficacy, high CRI and Dot-Free, it is designed to provide a flexible high quality linear lighting for a wide variety of applications for facade lighting and architectural lighting in hotels, restaurants, shops, offices and homes.

- High luminous efficiency, SMD2835, 2735, 5050, LM80 proved
- High light transmittance, environmental silicone material, integrated extrusion molding technology, IP67.
- Unique optical light distribution structure design, uniform lighting surface and no shadow.
- LO-SV3D1515 - Compitable for horizontal and vertical bending "3D".
- LO-SV1515 - Compitable for horizontal bending "Planer".
- Working/Storage Temperature: -20°~ 50°C / 0°C~ 60°C.



### Technical Specification

|                    |                               |                       |                      |         |
|--------------------|-------------------------------|-----------------------|----------------------|---------|
| Part number        | LO-SV1515-xx / LO-SV3D1515-xx | IP rating             | IP67                 |         |
| Power/meter        | 12W Max.                      | Bend ratio            | R60mm                |         |
| Input voltage      | DC 24V                        | Cut length            | 50mm                 |         |
| CCT                | 2400 2700 3000 4000 5000 5500 | Installation          | 3M tape              | Bracket |
| Lumen output/meter | 280Lm-590Lm                   | Maxrun                | Custom Size - Planer |         |
| CRI                | Ra+80, Ra+92, Ra+95, Ra+98    | Lifespan and warranty | 45,000 - 50,000Hrs   |         |

### LED TYPES *Our Unique LED types*

2835, 2735, 5050, 3V, 60mA, 150Lm/W, Ra+92



### CCT *The CCT Our LEDs Creates*

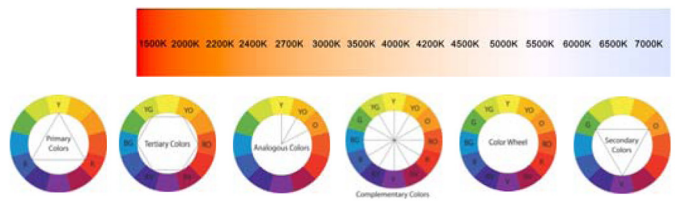

### CRI *True LED colors*



|          |     |     |
|----------|-----|-----|
| CRI (Ra) | R9  | R13 |
| >80      | >60 | >93 |
| >80      | >86 | >94 |
| >80      | >95 | >98 |

### MAXRUN *Less voltage drop*

Unique design on FPC to improve the voltage drop issue and extend the lifespan to the utmost.

|                 |                 |
|-----------------|-----------------|
| MAXRUN          | POWER/M         |
| 5meters (3D)    | 7.2W            |
| 10meters        | 8W / 9.6W       |
| Custom - Planer | 8W / 9.6W / 12W |

### Note

This linear LED product must be mounted in an appropriate approved surface or recessed channel. Failure to do so may result in a much shortened LED life, color shift and void the warranty.

## Structure Parameters

IP67 silicone end cap

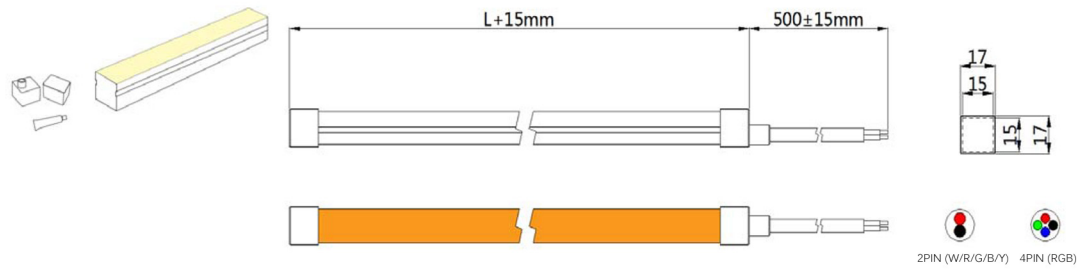

Bending application

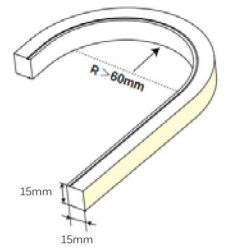

## Structure Parameters (3D)

IP67 silicone end cap

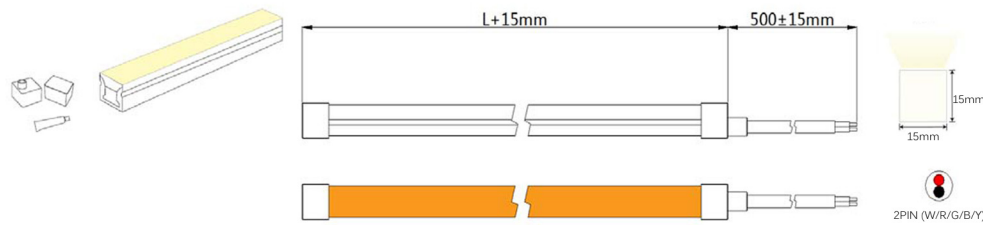

Bending application

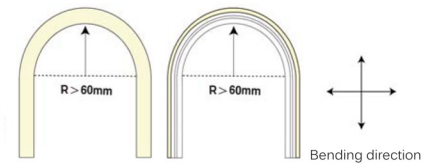

## Basic Parameters

| Model        | CCT/colors  | CRI | Input voltage (V) | Rated current (A) | Rated power (w) | Lumens (LM) | Size (mm) | Max.length | Cutting unit (mm) |
|--------------|-------------|-----|-------------------|-------------------|-----------------|-------------|-----------|------------|-------------------|
| LO-SV1515-XX | 2300K       | >80 | 24V               | 0.4               | 9.6             | 520         | W15*H15   | Custom     | 50                |
|              | 2700K       |     |                   |                   |                 | 580         |           |            |                   |
|              | 3000K       |     |                   |                   |                 | 590         |           |            |                   |
|              | 4000K       |     |                   |                   |                 | 580         |           |            |                   |
|              | R 620-630nm | /   |                   | 0.34              | 8               | R           |           |            |                   |
|              | G 525-530nm |     |                   |                   |                 | G           |           |            |                   |
|              | B 465-470nm |     |                   |                   |                 | B           |           |            |                   |
| Y 587-592nm  | Y           |     |                   |                   |                 |             |           |            |                   |
| LO-SV1515-XX | RGB         | /   | 24V               | 0.5               | 12              | /           | W15*H15   | Custom     | 83                |
|              | R 620-630nm |     |                   |                   |                 |             |           |            |                   |
|              | G 525-530nm |     |                   |                   |                 |             |           |            |                   |
|              | B 465-470nm |     |                   |                   |                 |             |           |            |                   |

## Basic Parameters (3D)

| Model          | CCT/colors  | CRI | Input voltage (V) | Rated current (A) | Rated power (w) | Lumens (LM) | Size (mm) | Max.length | Cutting unit (mm) |
|----------------|-------------|-----|-------------------|-------------------|-----------------|-------------|-----------|------------|-------------------|
| LO-SV3D1515-XX | 2200K       | >80 | 24                | 0.3               | 7.2             | 450         | W15*H15   | 5000mm     | 41.66             |
|                | 2800K       |     |                   |                   |                 | 510         |           |            |                   |
|                | 3200K       |     |                   |                   |                 | 510         |           |            |                   |
|                | 4400K       |     |                   |                   |                 | 500         |           |            |                   |
| LO-SV3D1515-XX | R 620-630nm | /   | 24                | 0.3               | 7.2             | /           | W15*H15   | 5000mm     | 41.66             |
|                | G 525-530nm |     |                   |                   |                 |             |           |            |                   |
|                | B 465-470nm |     |                   |                   |                 |             |           |            |                   |
|                | Y 587-592nm |     |                   |                   |                 |             |           |            |                   |

### Photometric Data

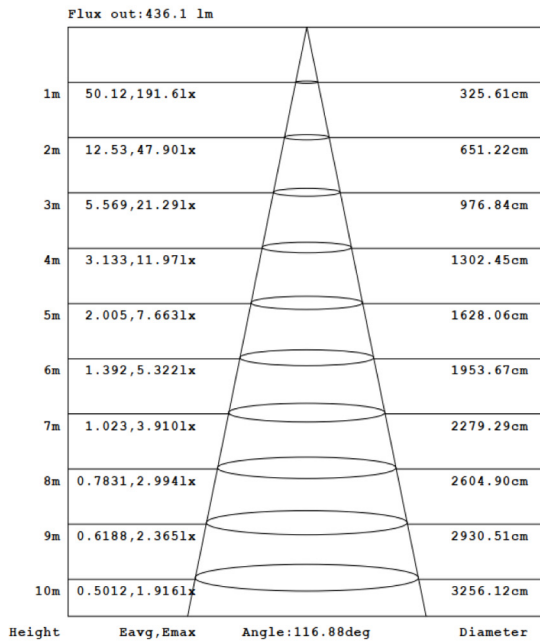

Effective average illuminance

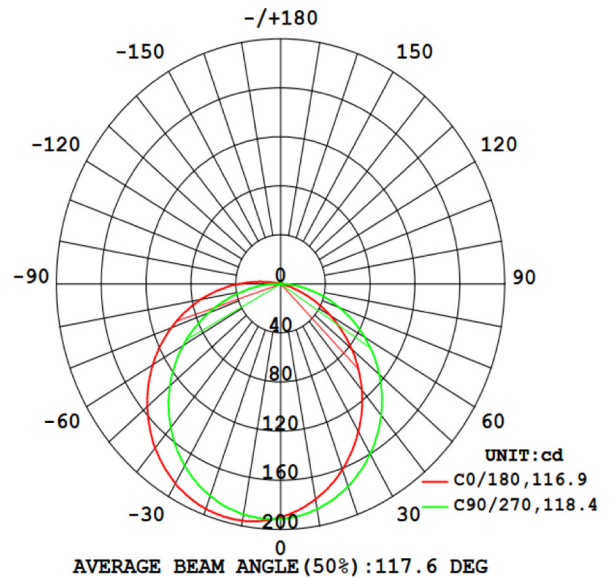

Light distribution

### Photometric Data (3D)

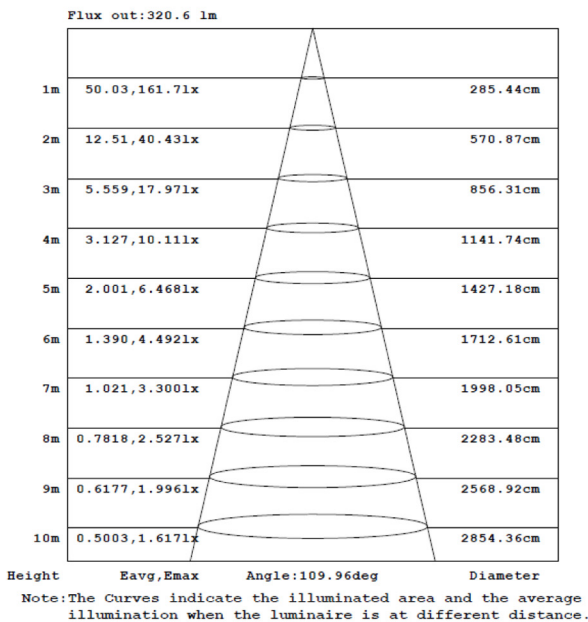

Effective average illuminance

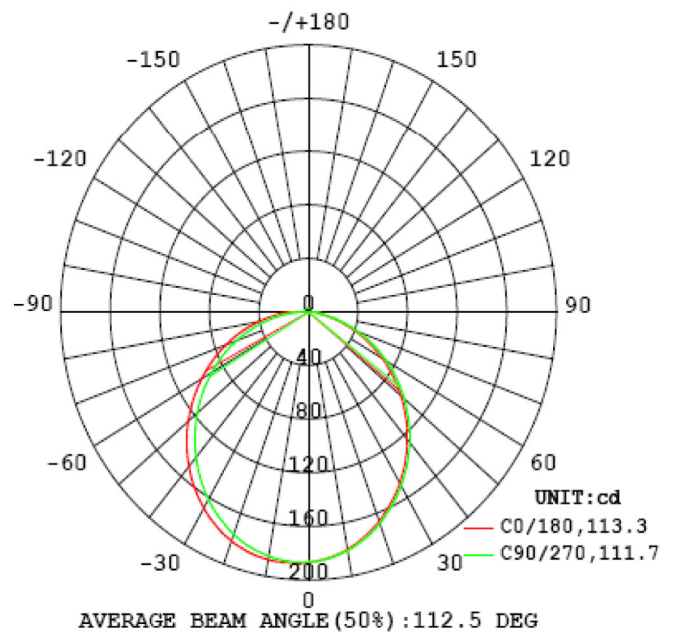





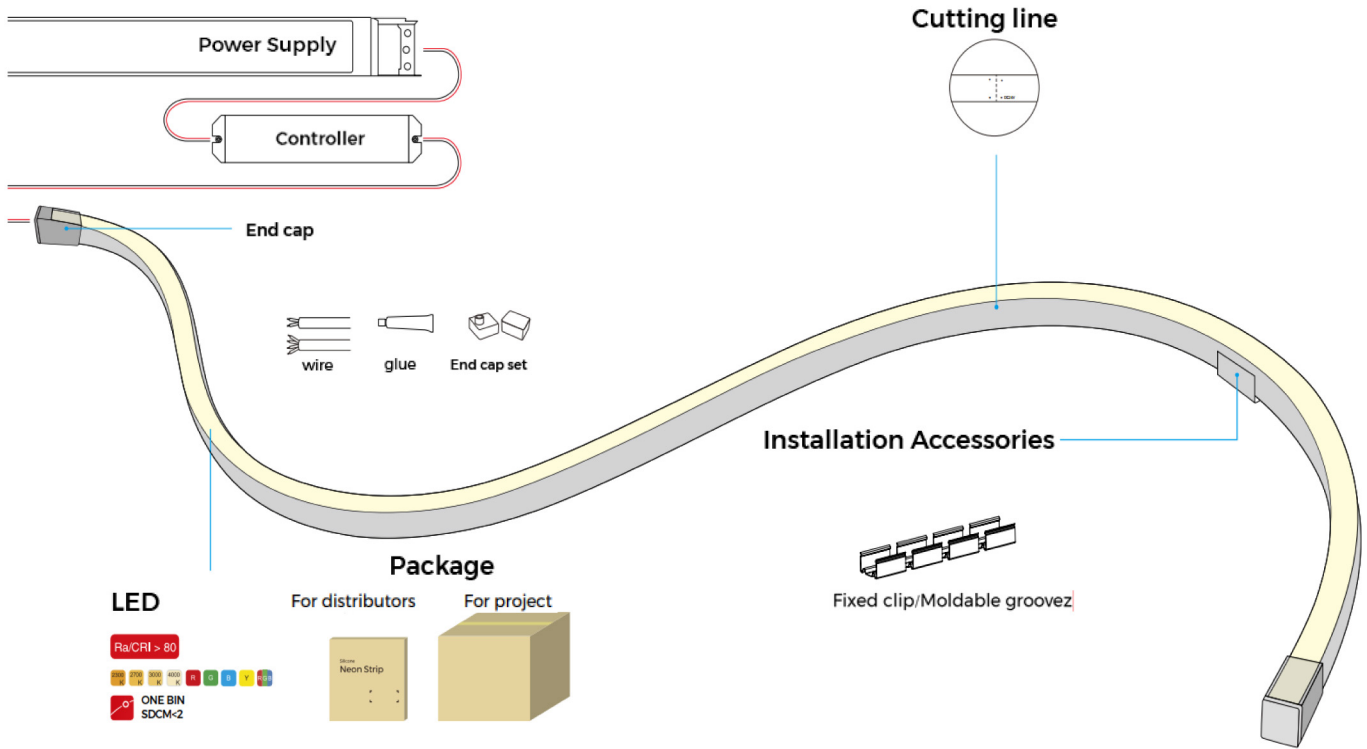



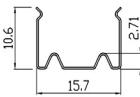

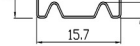

Light distribution

## System Solution









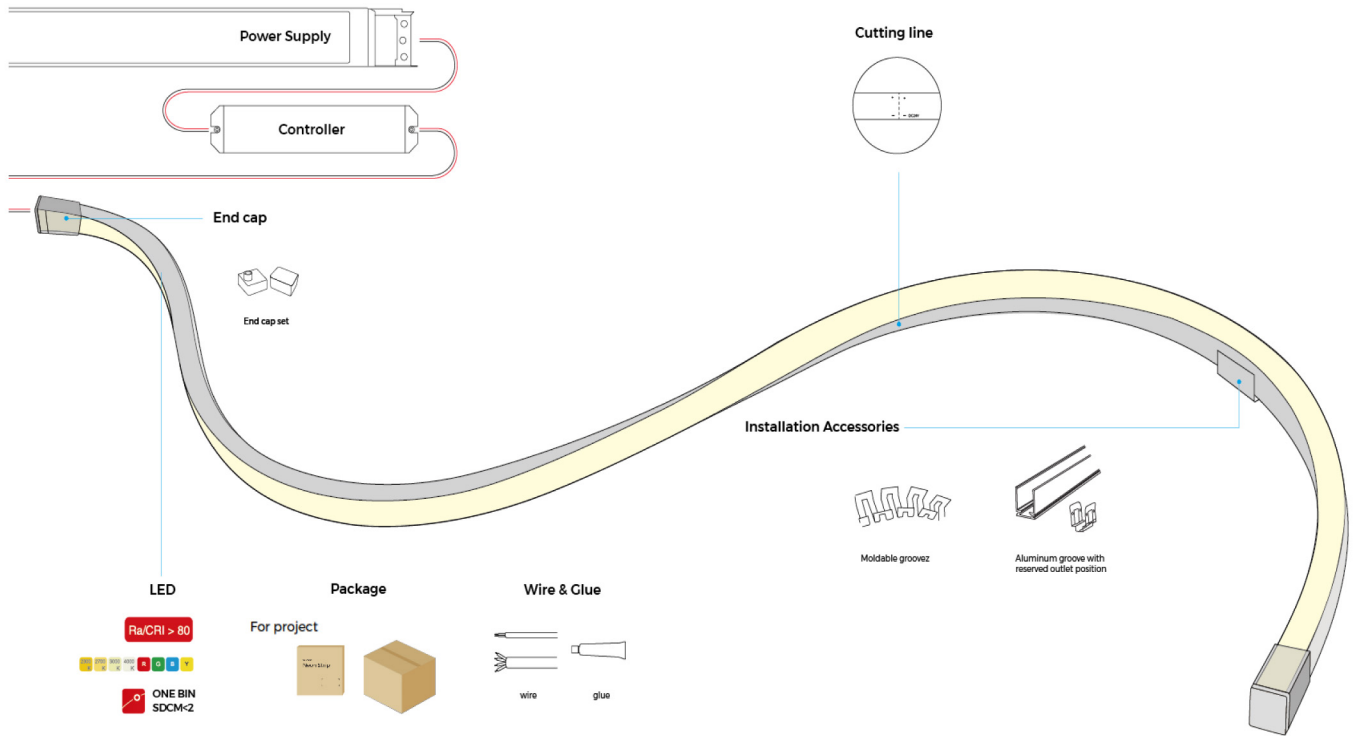



## Accessories

| Name             | Description                             | Image   | Sectional size  | Ordering code    | Product quantity /case (PCS) | Product quantity/case (kg) | Net weight per box (kg) | Gross weight (kg) | Gross weight (mm) | Remark                                   |
|------------------|---|---|---|------------------|------------------------------|----------------------------|-------------------------|-------------------|-------------------|--|
| Moldable carrier | Moldable groovez                        |  |  | AS-NMT1515M-1000 | 50                           | 0.091                      | 4.55                    | 5.15              | 500*290*290       | Size : L1000*W16.2*H10.6mm , with screws |
| Stainless clip   | Fixed clip                              |  |  | AS-NMT1515S-95   | 200                          | 0.0095                     | 1.9                     | 2.1               |                   | Size : L95*W16.2*H10.6mm , with screws   |
| End cap set      | End cap set, including end cap and plug |  |  | AS-NMT1515GH0-EC | 400                          | 0.003                      | 1.2                     | 1.5               |                   | /  |
| Glue             | 588G acidic glue                        |  | /   | AS-PG-0002       | 150                          | 0.014                      | 2.1                     | 2.4               | 250*250*150       | 10ml/pcs                                 |
| Wire             | 2P PVC wire ( 0.5M )                    |  | /   | AS-WS-0001       | 150                          | 0.01541                    | 2.31                    | 2.61              |                   | Suitable for single color strip          |
| Wire             | 2P PVC wire ( 2M )                      |  | /   | AS-WS-0002       | 125                          | 0.0616                     | 7.7                     | 8                 |                   | Suitable for single color strip          |
| Wire             | 4P PVC wire ( 0.5M )                    |  | /   | AS-WS-0003       | 150                          | 0.0194                     | 2.91                    | 3.21              |                   | Suitable for RGB strip                   |
| Wire             | 4P PVC wire ( 2M )                      |  | /   | AS-WS-0004       | 125                          | 0.0776                     | 9.7                     | 10                |                   | Suitable for RGB strip                   |
| Connector        | 2PIN IP68 waterproof connector          |  | /   | AS-FC-0001       | 512                          | 0.016                      | 8.192                   | 9.5               |                   | Suitable for single color strip          |
| Connector        | 4PIN IP68 waterproof connector          |  | /   | AS-FC-0003       | 288                          | 0.03                       | 8.64                    | 9.6               | 365*365*190       | Suitable for RGB strip                   |



## System solution (3D)



## Accessories (3D)

| Name             | Description                             | Image   | Sectional size  | Ordering code      | Product quantity/case (PCS) | Product quantity/case (kg) | Net weight per box (kg) | Gross weight (kg) | Gross weight (mm) | Remark                                 |
|------------------|---|---|---|--------------------|-----------------------------|----------------------------|-------------------------|-------------------|-------------------|--|
| Alumina carrier  | Pre-installed aluminium groove          |  |  | AS-NM3D1515A2-1000 | 12                          | 0.18                       | 2.16                    | 3.16              | 1290*112*50       | Size : L1000*W18.6*H19.3MM with screws |
| Moldable carrier | Moldable groove                         |  |  | AS-NM3D1515M-500   | 100                         | 0.045                      | 4.5                     | 7.3               | 500*290*290       | Size : L500*W16.4*H16 with screws      |
| End cap set      | End cap set, including end cap and plug |  |  | AS-NM3D1515GH0-EC  | 400                         | 0.003                      | 1.2                     | 1.5               | 250*250*150       | /                                      |
| Glue             | 588G acidic glue                        |  | /   | AS-PG-0001         | 150                         | 0.014                      | 2.1                     | 2.4               | 250*250*150       | 10ml/pcs                               |
| Wire             | 2P PVC wire (0.5M)                      |  | /   | AS-WS-0001         | 150                         | 0.01541                    | 2.31                    | 2.61              | 250*250*150       | Suitable for white light strip         |
| Wire             | 2P PVC wire (2M)                        |  | /   | AS-WS-0002         | 125                         | 0.0616                     | 7.7                     | 8                 | 250*250*150       |  |
| Connector        | 2PIN IP68 waterproof connector          |  | /   | AS-FC-0001         | 512                         | 0.016                      | 8.192                   | 9.5               | 365*365*190       | Suitable for white light strip         |

## Solution of controll system

| Name   | Model    | Ordering Code | Parameters  | Dimming constant-voltage acceptor  | Suitable Products |
|--|----------|---------------|---|--|-------------------|
|  Single color dimming set | M1+M4-5A | 23-01-00-0045 | Operating voltage: 3VDC (Battery CR2032)<br>Operating frequency: 433.92MHz<br>Remote control distance: 30m<br>Operating temperature: -30°C 55°C | Input voltage: 12-24VDC<br>Maximum loaded current: 5A*4CH Max 20A<br>Maximum loaded power:240W/480W(12V/24V)<br>Operating temperature: -30°C 55°C<br>Size: L170*W44*H30(mm)<br>Package size: L228*W155*H32(mm) | White color strip |
|  RGB set                  | M3+M4-5A | 23-01-00-0046 | Operating voltage: 3VDC (Battery CR2032)<br>Operating frequency: 433.92MHz<br>Remote control distance: 30m<br>Operating temperature: -30°C 55°C | Input voltage: 12-24VDC<br>Maximum loaded current: 6A*3CH Max 18A<br>Maximum loaded power:216W/432W(12V/24V)<br>Operating temperature: -30°C 55°C<br>Size: L170*W44*H30(mm)<br>Package size: L228*W155*H32(mm) | RGB LED strip     |

## Wiring Diagram

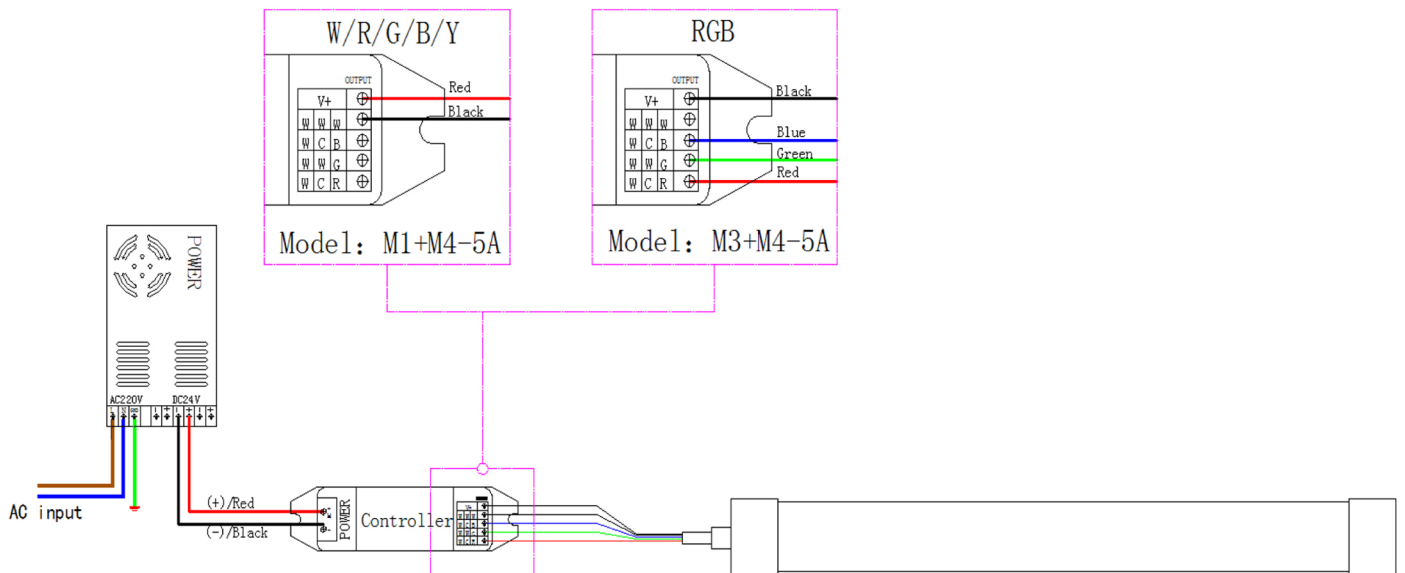

## Wiring Diagram (3D)

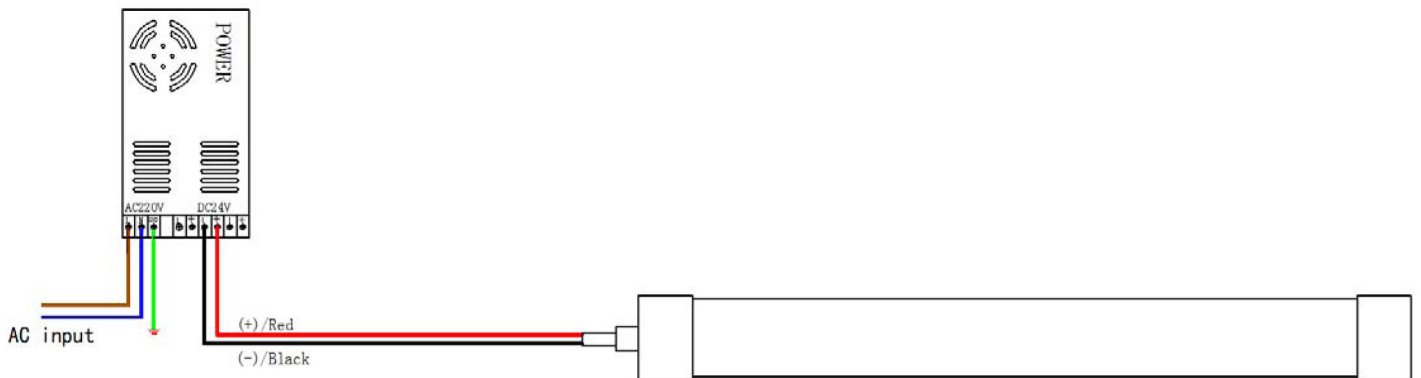

## Installation Guidance

### Installation of Clip

1. Use screws to fix the clips or carriers on the mounting position

⚠️ Clip: 3 clips can be used for 1m;

### Installation of Carrier

1. When installing the LED strip, install it from both ends at the same time, installation from one direction is prohibited.

⚠️ If the length of LED strip is over 2m, it is recommended to install by two persons.

> 2m

2. Use tool to disassemble carefully, and do not pull the LED strip directly.

⚠️ If the length of LED strip is over 2m, it is recommended to disassemble by two persons.

> 2m

**NEW 3D**

Top bend & side bend,  
limitless applications

Silicone Neon Strip LO-SV3D1515